

CHEMICAL CENTRIFUGAL PUMP MC model

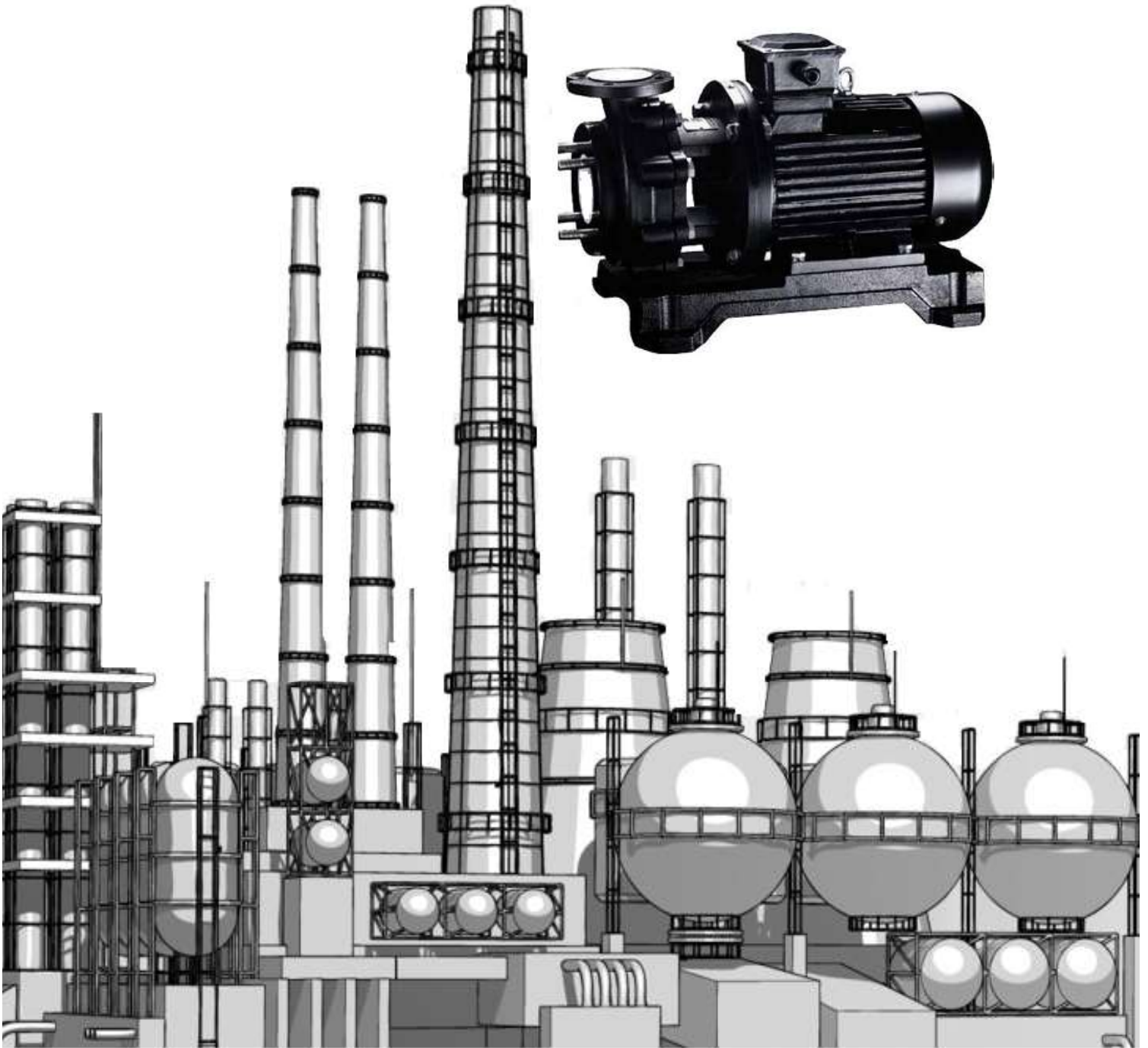

We are professional engineers for energy saving pump & piping

Performance curve :

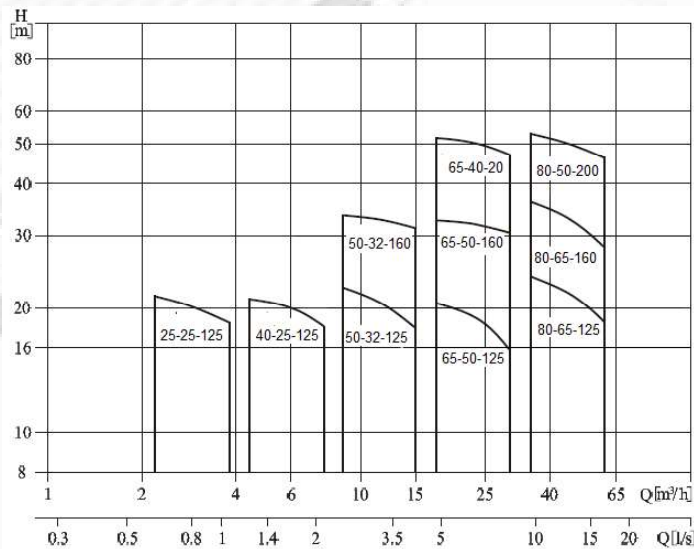

Specification :

- Maximum flow 55 M3/hour
- Maximum head 50 meter
- Liquid temperatur -20 deg.C to 120 deg.C
- Maximum working pressure 10Bar
- Inlet/outlet diameter DN25 - DN80

Electric motor :

- 3Ph/380V-415V/50Hz/2P
- 1Ph/220V-240V/50Hz/2P
- Insulation class F, protection clas IP55
- Maximum power : 18,5 kW

Application :

- Industrial : Chemical process/circulation (Petrol, chemical, acid cleaning, galvanization, pesticide)
- Water Treatment : Chemical process/circulation
- Sea water desalination : Transfer
- Liquid with concentration of acid alkaly, strongly corrosive, salty, strongly oxidant, fuel/solar

Engineering & pricing solution

The energy saving & long life time of pump is our focus. The pump energy saving is not only determined by pump efficiency, but also depending by pipe diameter, controller, etc. Therefore we are ready to give consultation or training of piping engineering (Free of charge) before purchase the pumps, for as below :

- Calculation to determine the pump flow & total head, pipe diameter & material (inlet/ outlet pipe)
- To avoid cavitation, the suction pipe (negative/positive suction) should be calculated max. suction lift (Hs).
- Selection of pump controller according to the application system
- Selection of pump type according to flow, total head, material and electrical power
- Selection of cheaper price with similar or better pump & application

Konsultasi : WA, BIP 0877 7067 8615, email : engineering@newtonus.com, engineering.newtonus@gmail.com

Performance curve :

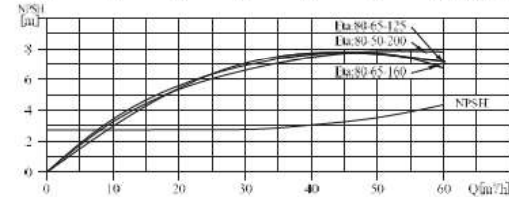
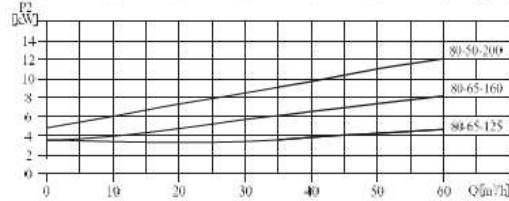
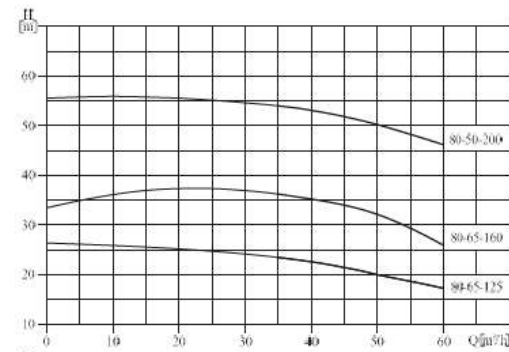
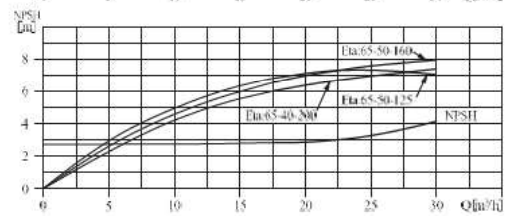
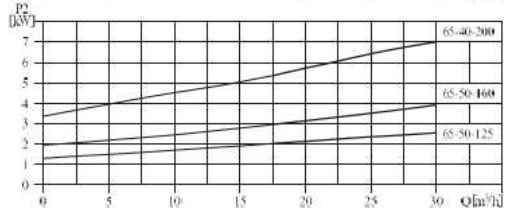
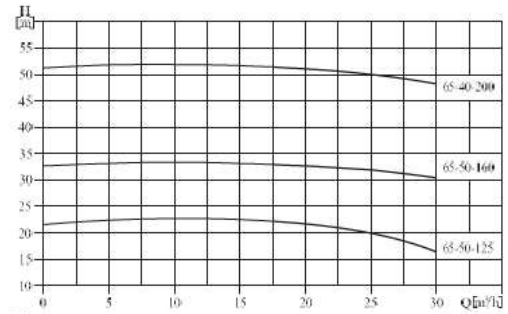
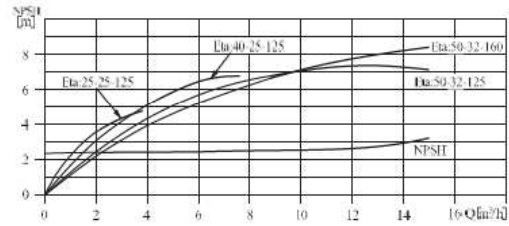
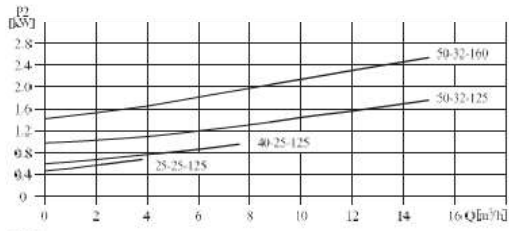
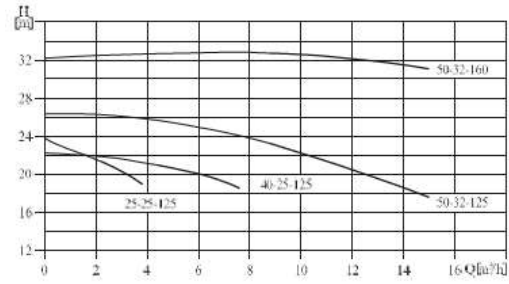

Dimension :

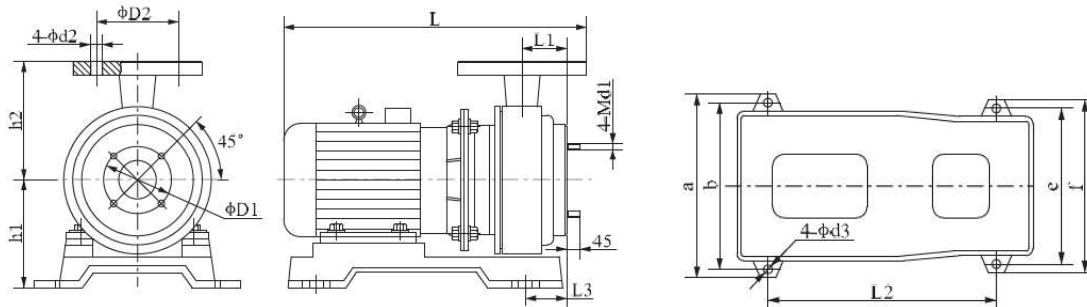

Model	KW	Size (mm)															Kg	Inlet/ Outlet
		L	L1	L2	L3	D1	d1	h1	h2	D2	d2	a	b	d3	e	f		
25-25-125	1.1	457	37	300	64	75	10	164	120	100	14	265	230	15	230	265	45	DN25/DN32
40-25-125	1.5	461	37	300	72	100	10	165	120	100	14	265	230	15	230	265	48	DN40/DN32
50-32-125	3	531	43	370	79	125	14	175	140	100	14	275	235	17	235	275	74	DN50/DN32
50-32-160	4	553	53	370	103	125	14	191	159	100	14	315	270	17	270	315	78	
65-50-125	4	563	50	370	95	145	14	175	147	125	18	315	270	17	270	315	79	DN65/DN50
65-50-160	5.5	618	51	400	88	145	14	219	165	125	18	370	330	17	290	335	113	
65-40-200	11	727	55	440	96	145	14	255	180	110	18	425	380	19	320	365	181	DN65/DN40
80-65-125	7.5	631	52	400	88	160	14	219	165	145	18	370	330	17	290	335	123	DN80/DN65
80-65-160	11	750	57	440	97	160	14	255	186	145	18	425	380	19	320	365	183	
80-50-200	18.5	797	57	440	110	160	14	255	195	125	18	425	380	19	320	365	205	DN80/DN50

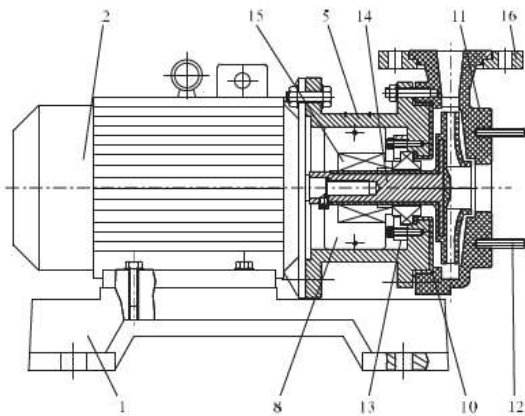

No.	Name	Material
1	Base	ASTM25B
2	Motor	
5	Injection moulding pump head	ASTM25B+F26(F46)
8	Guard	AISI304
10	O ring	FPM
11	Casing	F26(F46)
12	Double end studs	AISI304
13	Seal cover	ASTM25B
14	Impeller	ASTMA570+F26(F46)
15	Mechanical seal	Silicon Carbide/Silicon Carbide
16	Outlet flange	ASTM25B